



ORGAN® NEEDLES NEEDLE-INDEX



COMBI

for technical details please refer to the different needle types listed further in this leaflet

These needles are suitable for most common sewing activities.

REMARKS:

This box offers a mixed assortment of UNIVERSAL, JEANS and STRETCH needles.

JEANS and STRETCH with colored shank for easy identification.



EL x 705 CR SERGER COVERSTICH

light ball point needle

This needle is suitable for over lock (cover-stitch) machines, which make over lock, cover and safety stitches.

REMARKS:

chromium finished for high performance, deep scarf, double grooved for a good thread tension.

Not appropriate for normal domestic sewing machines.



EL x 705 CR SUK SERGER COVERSTICH

medium ball point needle
6 needles per Box

This needle is suitable for over lock (cover-stitch) machines, which make over lock, cover and safety stitches.

REMARKS:

chromium finished for high performance, deep scarf, double grooved for a good thread tension. The medium ball point prevents thread breakages of the fabric (needle hole)

Not appropriate for normal domestic sewing machines.

available needle sizes:

Blister-Pack & Plasticbox with 5 or 10 needles: various sizes
assortment with 10 needles

available needle sizes:

Blister-Pack & Plasticbox à 5 needles: sizes 75, 80, 90
Eco-Pack à 5 needles: sizes 80, 90
envelope à 10 needles: sizes 75, 80, 90

available needle sizes:

Blister-Pack & Plasticbox
80 + 90 assortment in plastic box à 6 needles



EMBROIDERY

130/705H-EB

Light ball point needle for multi-directional stitching

This needle is suitable for embroidery sewing with thicker thread and multi directional stitching.

REMARKS:

Embroidery requires sewing in multiple directions. This is much different from normal sewing. Therefore there are many movements and twists of the thread. As a result upper thread damage and skipped stitches might occur.

Equipped with larger needle eye (length and width of eye) enabling the use of a large variety of embroidery threads, including thick thread. A cliff scarf contributes to stable and larger loop formation, in order to prevent skipped stitches. The light ball point avoids damages of the embroidery thread.

available needle sizes:

Blister-Pack & Plasticbox à 5 needles: sizes 75 (Bluetip) assortment: 75 - 90
Eco-Pack à 5: sizes: 75 / assortment: 75 - 90



JEANS

130/705H-DE

slim ball point needle for denim
blue colored shank

This needle is suitable for sewing Jeans, canvas, coated fabrics, flannel, artificial leather or similar thick fabrics.

REMARKS:

The slim ball point reduces the penetration resistance and prevents needle and thread breakages.

available needle sizes:

Blister-Pack & Plasticbox à 5 needles: sizes 90, 100, 110 assortment: 90 - 100
Eco-Pack à 5 needles: sizes 90, 100 / assortment: 90 - 100



JERSEY

130/705H

medium ball point needle for general knitted fabrics

This needle is suitable for sewing woven + knitted fabrics like single jersey, fleece & helanca.

available needle sizes:

Blister-Pack & Plasticbox à 5 needles: sizes 70,80,90,100 assortment: 70 - 100
Eco-Pack à 5: sizes 60,70,80,90 / assortment: 70 - 100
Envelope à 10 needles: sizes : 70, 80, 90, 100,110



LEATHER

130/705H-LL

narrow twist (cutting) point needle

This needle is suitable for all kinds of leather and suede sewing.

REMARKS:

When sewing a fiber-crowded fabric, the needle hole tends to be too small.

With its unique knife shaped point shape the needle makes stable sized needle holes. Also useful for making angle stitches

available needle sizes:

Blister-Pack & Plasticbox à 5 needles: assortment: 90 - 100
Eco-Pack à 5 needles: assortment: 90 - 100
Envelope à 10 needles: sizes 70, 80, 90, 100, 110, 120



METAL

130/705H-MF

light ball point needle for sewing with metallic thread

This needle is suitable for embroidery sewing with metallic (gold/silver) threads or specially treated threads.

REMARKS:

This needle has an enlarged needle eye (twice longer compared to UNIVERSAL and four times wider than UNIVERSAL). This minimizes the pressure of the metallic thread.

Metallic threads have delicate foliations on the surface, which can be removed easily. By using this needle the trouble of peeling thread surfaces can be reduced as well as thread breakages.

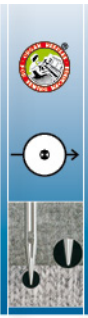

MICROTEX

130/705H-HM

slim sharp point needle for micro fabrics

This needle is suitable for sewing fine clothes like batiste, chiffon, organdy, lace, linen, toweling or any other microfiber.

REMARKS:

Due to the slim sharp point the penetration resistance is reduced and prevents needle and thread breakage.

High density material is protected from wrinkles.

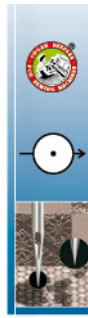

MULTI

for technical details please refer to the different needle types listed further in this leaflet

These needles are suitable for most common sewing activities.

REMARKS:

This box offers a mixed assortment of UNIVERSAL, JEANS, STRETCH and TWIN needles.

JEANS and STRETCH with colored shank for easy identification.



QUILTING

130/705H-QU

slim sharp point needle for machine quilting

This needle is suitable for quilting and patchwork sewing and also recommended for the sewing of button holes.

REMARKS:

The flattening angle of this needle is larger, which makes the rotating hook come closer to the scarf of the needle. In this way the hook can catch the loop securely even if the loop formation is unstable. The cliff-scarf supports the formation of larger loops and the upward movement of the upper thread. It also prevents skipped stitches. The slim tapered shape from the needle eye to the needle tip makes needle holes become smaller and the appearance of cotton fibers inside the material is reduced. This slim shape also reduces the penetration resistance when sewing the thick quilts.

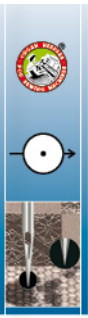

available needle sizes:

Blister-Pack & Plasticbox à 5 needles: assortment: 90 -100

available needle sizes:

Blister-Pack & Plasticbox à 5 needles: assortment: 60 -70
Eco-Pack à 5 needles: sizes: 60,70,80

available needle sizes:

Blister-Pack & Plasticbox à 5 needles: various assortments

available needle sizes:

Blister-Pack & Plasticbox à 5 needles: assortment: 75 - 90
Eco-Pack à 5 needles: assortment: 75 - 90



SILK

HA x 1 GT

normal round ball point in small size

smallest available needle size for domestic needles

This needle is suitable for sewing velvet, satin, silk, swim wear and lingerie.

REMARKS:

This needle has an enlarged needle eye in relation to the needle size, a wider groove in relation to the needle size and a tapered shank against puckering and skipped stitches.

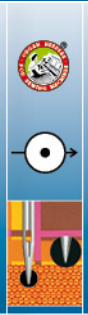

SUPER-STRETCH

HA x 1 SP

medium ball point needle for low gauge fabrics

This needle is suitable for sewing simplex, latex, Lycra, sportswear fabrics and general elastics.

REMARKS:

This needle has following countermeasures against the main troubles, when sewing knitwear. The thickened eye section of the needle continuously enlarges the penetration area. The medium ball point prevents thread breakages of the fabric (needle hole).

A specially formed scarf helps to avoid skipped stitches by giving enough clearance to the rotating hook. Loop formation becomes stable and the loops are caught securely by the hook.

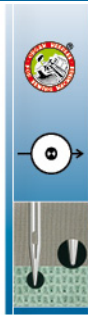

TITANIUM

130/705H-PD

light ball point needle for heavy duty and embroidery sewing

This needle is suitable for semi-professional general sewing.

REMARKS:

The needle surface is coated with titanium nitride for a longer needle life.

The strength is increased by high hardness, in combination with perfect durability and excellent anti-abrasion resistance.

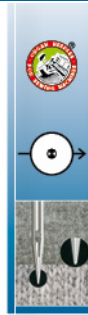

TOP-STITCH

130 N

light ball point needle for special stitches

This needle is suitable for quilting seams with thicker threads. It can also be used for the sewing of button holes, for decorative stitches with thicker threads and for repair embroidery.

REMARKS:

This needle has a larger and longer needle eye. The groove is wider in relation to the thickness of the needle and the distance from eye to butt is shorter compared to UNIVERSAL needles.



available needle sizes:

Blister-Pack & Plasticbox à 5 needles: sizes: 55

Blister-Pack & Plasticbox à 5 needles: sizes: 65, 75, 90
assortment: 5 or 10 needles: 75-90

Eco-Pack à 5 needles: sizes: 75 / assortment: 75-90
Envelope à 10 needles: sizes: 75-90

available needle sizes:

Blister-Pack & Plasticbox à 5 needles: assortment: 75, 80, 90
Eco-Pack à 5 needles: sizes: 75,80,90
Envelope à 10 needles: sizes: 75, 80, 90

available needle sizes:

Blister-Pack & Plasticbox à 5 needles: sizes: 80, 90
Plasticbox also available as Titanium: sizes 70, 80, 90,100
Eco-Pack à 5 needles: sizes: 80, 90



TWIN

130/705HZ

regular point

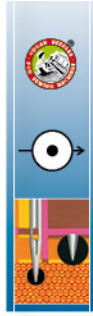

This needle is suitable for sewing braids and for creating decorative stitches

REMARKS:

needle distance	1.4 mm	size	70
needle distance	1.6 mm	size	70
needle distance	2 mm	sizes	70, 80 + 90
needle distance	2.5 mm	size	80
needle distance	3 mm	size	80 + 90
needle distance	4 mm	size	80, 90 + 100



TWIN

130/705HZ

regular point

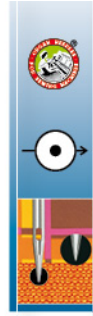

This needle is suitable for sewing braids and for creating decorative stitches

REMARKS:

needle distance	6 mm	size	100
-----------------	------	------	-----

especially wide needle distance



TWIN-STRETCH

HZx705 HSB

medium ball point needle



This needle is suitable for sewing stretch material like knit and sportswear fabrics and for creating decorative stitches.

REMARKS:

needle distance	2.5 mm	size	75
needle distance	4 mm	size	75

This needle has a special designed shape and medium ball point for better loop formation, thus preventing skipped stitches and fabric yarn breakages.



ANTIGLUE

130/705H-EB

light ball point needle for multi-directional stitching

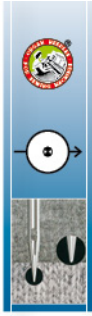

This needle is suitable for materials, which are fixed with adhesive sprays, e.g. fleece or Velcro.

REMARKS:

FOR TROUBLE BY REMAINDERS OF ADHESIVE SPRAYS IN GROOVE AND EYE.

ANTI-GLUE needles significantly reduce the appearance of glue remainders in the groove and the eye of the needle. The life time of ANTI-GLUE needles is remarkably longer in comparison with ordinary embroidery needles. The needle surface is coated with an anti-adhesion layer.

available needle sizes:

Blister-Pack & Plasticbox à 5 needles:

sizes: 75



UNIVERSAL

130/705H

normal round point needle for general domestic sewing

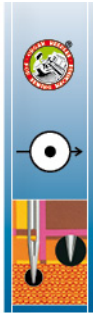

This needle is suitable for sewing suede, corduroy, organdy, batiste, linen, poplin broadcloth and others.

REMARKS:

also available as twin needle

basic needle knowledge

Sewing machine needles should be replaced regularly, because worn out needles can cause damages to delicate fabrics.

Blunt or bent needles will produce skipped stitches and thread breakages.

In extreme cases the usage of worn out needles can result in damages of the stitching plate and surrounding parts.

After use we recommend to put the needles back into the original boxes. This is a good place for keeping them and mismatching with other needles and sizes is excluded.

needle parts

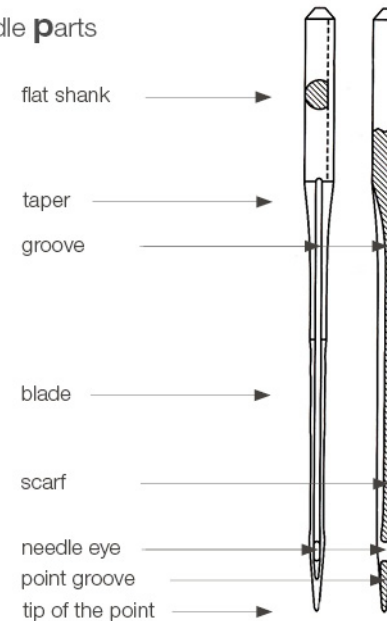

Blister-Pack & Plasticbox à 5 needles: sizes: 60-120

assortment: 5 or 10 needles: various

Eco-Pack à 5 needles: sizes: 60-120 assortment: 70-100

Envelope à 10 needles: sizes: 60-140